



## NC-FD8-M/W3R3(E)

Key features: 8MP fixed lens dome network camera, 1 built-in microphone, 30m infrared light and 30m white light supplements

Camera	
Model	NC-FD8-M/W3R3(E)
Product Name	8MP Outdoor Smart Hybrid light Fixed Lens Turret Network Camera
Image Sensor	1/2.7" Progressive Scan CMOS
Resolution	3840(H) × 2160(V)
Min. Illumination	Color: 0.01 Lux @ (F2.0, AGC ON), B/W: 0 Lux with IR
Shutter Time	1/3 s to 1/100,000 s
Day & Night	IR Cut Filter
Angle Adjustment	Pan: 0° to 360°, Tilt: 0° to 90°, Rotation: 0° to 360°
Lens	
Lens Type	Fixed focal lens, 2.8 mm, 4.0 mm available
Field of View	2.8 mm, horizontal FOV 113°, vertical FOV 62°, diagonal FOV 134° 4.0 mm, horizontal FOV 90°, vertical FOV 49°, diagonal FOV 108°
Lens Mount	M12
Iris Type	Fixed
Aperture	F2.0
DORI	
DORI	2.8 mm, D: 79 m, O: 31 m, R: 15 m, I: 7 m 4.0 mm, D: 102 m, O: 40 m, R: 20 m, I: 10 m
Night Vision	
Supplement Light Type	IR light and white light
Supplement Light Range	Up to 98ft (30 meters)
IR Wavelength	850nm
Video	
Main Stream	50 Hz: 12.5 fps (3840 × 2160, 3200 × 1800, 2688 × 1520, 1920 × 1080, 1280 × 720) 60 Hz: 15 fps (3840 × 2160, 3200 × 1800, 2688 × 1520, 1920 × 1080, 1280 × 720)
Sub Stream	50 Hz: 12.5 fps (1280 × 720, 640 × 480, 640 × 360) 60 Hz: 12.5 fps (1280 × 720, 640 × 480, 640 × 360)

# UNO-IOT Products Datasheet

Video Compression	Main stream: H.265+/H.265/H.264+/H.264; Sub-stream: H.265/H.264/MJPEG
Video Bit Rate	32 Kbps to 16 Mbps
H.264 Type	Baseline Profile, Main Profile, High Profile
H.265 Type	Main Profile
Bit Rate Control	CBR, VBR
Region of Interest (ROI)	1 fixed region for main stream
Scalable Video Coding (SVC)	H.264 and H.265 encoding
<b>Audio</b>	
Audio Type	Mono sound
Environment Noise Filtering	Yes
Audio Sampling Rate	8 kHz/16 kHz
Audio Compression	G.711ulaw/G.711alaw/G.722.1/G.726/MP2L2/PCM/AAC-LC
Audio Bit Rate	64 Kbps (G.711 ulaw)/64 Kbps (G.711 alaw)/16 Kbps (G.722.1)/16 Kbps (G.726)/32 to 160 Kbps (MP2L2)/16 to 64 Kbps (AAC-LC)
<b>Network</b>	
Security	Password protection, complicated password, watermark, basic and digest authentication for HTTP, WSSE and digest authentication for Open Network Video Interface, security audit log, host authentication (MAC address)
Simultaneous Live View	Up to 6 channels
API	Open Network Video Interface (Profile S, Profile T, Profile G), ISAPI, SDK,
Protocols	TCP/IP, ICMP, DHCP, DNS, HTTP, RTP, RTSP, NTP, IGMP, IPv6, UDP, QoS, FTP, SMTP
User/Host	Up to 32 users, 3 user levels: Administrator/Operator/User
Web Browser	Plug-in required live view: IE 10, IE 11, local service: Chrome 57.0+, Firefox 52.0+
<b>Image</b>	
Wide Dynamic Range (WDR)	120 dB
SNR	≥ 52 dB
Day/Night Switch	Day, Night, Auto, Schedule
Image Enhancement	BLC, HLC, 3D DNR
Image Settings	Rotate mode, saturation, brightness, contrast, sharpness, gain, white balance, adjustable by client software or web browser
Privacy Mask	4 programmable polygon privacy masks
<b>Interface</b>	
Ethernet Interface	1 RJ45 Ethernet port, 10 M/100 M self-adaptive
Factory Reset	Support
Expansion Slot	MicroSD/microSDHC/microSDXC card, up to 512 GB
Microphone	1 built-in microphone
Speaker	N/A
Audio In/Out	N/A
Alarm In/Out	N/A
<b>Event</b>	
Basic Event	Motion detection (support alarm triggering by specified target types (human and vehicle)), video tampering alarm, exception
Linkage	Upload to FTP/memory card, send email, notify surveillance center, trigger recording, trigger capture







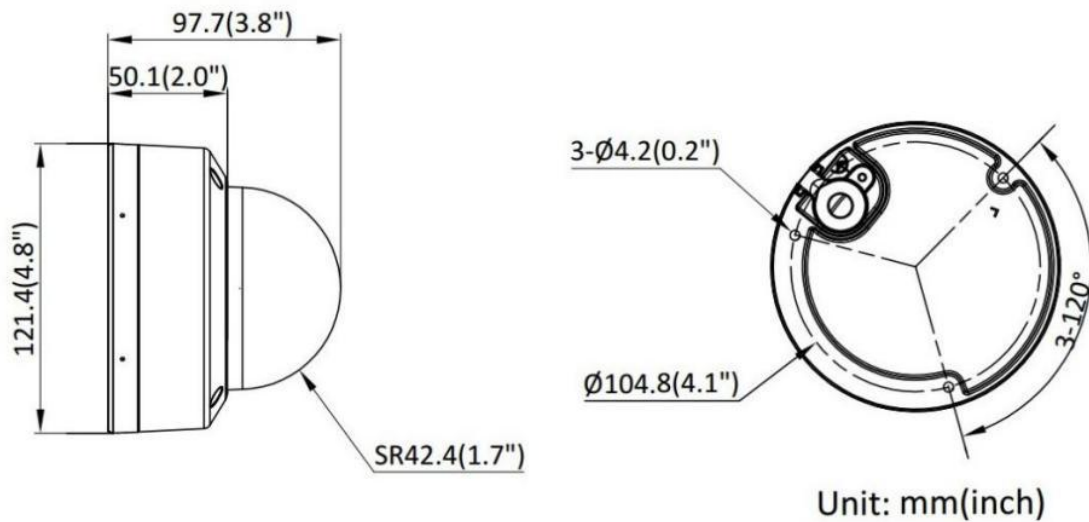

## General

Startup and Operating Conditions	-30 °C to 60 °C (-22 °F to 140 °F). Humidity 95% or less (non-condensing)
Storage Conditions	-30 °C to 60 °C (-22 °F to 140 °F). Humidity 95% or less (non-condensing)
Power Supply	PoE: IEEE 802.3af, Class 3, max. 7.5 W 12 VDC ± 25%, 0.5 A, max. 6 W, Ø 5.5 mm coaxial power plug, reverse polarity protection,
Protection Level	IP67
Material	Base: Metal, Cover: Plastic
Dimension	Ø 121.5 mm × 97.6 mm (Ø 4.78" × 3.84")
Weight	Approx. 550 g (1.2 lb.)
Language	English, Ukrainian

## Dimension

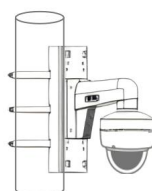

## Accessories (optional)

Junction Box	Wall Mount	Vertical Pole Mount	Junction Box
DS-1272ZJ-120	DS-1272ZJ-120B	DS-1275ZJ-SUS	DS-1276ZJ-SUS
			
			

**Pendant Mount**

**DS-1271ZJ-120**

